

**Technical Features**

- › Proportional directional control spool valve with subplate mounting surface acc. to ISO 4401 (size 04) and DIN 24340 (CETOP 02)
- › The valve is designed for control of movement direction of actuator and continuous speed regulation in the given range
- › The volumetric flow through the valve is proportional to the electrical input command signal
- › Manual override
- › Spool position sensor with 520h corrosion protection
- › Wide range of electrical connectors
- › Adjustable position of coil connector suitable for mounting
- › In the standard version, the valve housing is phosphated for basic surface corrosion protection and as preparation for painting. Steel parts are zinc-coated for 240 h salt spray protection acc. to ISO 9227
- › Enhanced surface protection for mobile sector available for the valve housing and steel parts (ISO 9227, 520 h salt spray)

**Functional Description**

The proportional directional control valve is designed to control direction of the movement, speed and position of the piston rod of hydraulic cylinder or shaft of hydraulic motor. The speed of movement is proportional to the volumetric flow through the valve, which is continuously regulated by throttling at the control edges of spool, proportionally to the input command signal. An electronic control unit (ECU) EL7 is used for the valve control. The ECU converts the input command signal into an output current control PWM signal for solenoid coils. The ECU EL7 is available as external for connection to the DIN rail (EL7-E, see datasheet HA 9152) or integrated on the valve in the form of connector plug (EL7-I, see datasheet HA 9151). The valve is equipped with a spool position sensor. However, its output signal is intended for the machine control system and cannot be connected to the valve control loop via ECU EL7.

**Technical Data**

ISO 4401-02-01-0-05

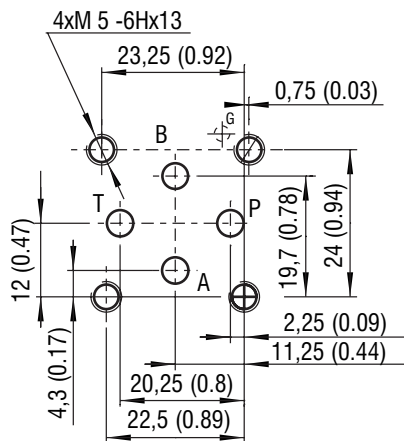

Ports P, A, B and T - max.  $\varnothing$ 4.5 mm (0.18 in)

Valve size		04 (D02)
Max. operating pressure at port P, A, B	bar (PSI)	320 (4580)
Max. operating pressure at port T	bar (PSI)	210 (3050)
Fluid temperature range (NBR)	°C (°F)	-30 ... +80 (-22 ... +176)
Fluid temperature range (FPM)	°C (°F)	-20 ... +80 (-4 ... +176)
Ambient temperature range	°C (°F)	-30 ... +50 (-22 ... +122)
Hysteresis	%	≤ 6
Nominal flow rate $Q_n$ at $\Delta p=10$ bar (145 PSI)	l/min (GPM)	4 (1.1) 8 (2.1) 12 (3.2)
Enclosure type acc. to EN 60529		IP65 / IP67 (see Dimensions, page 5)
Weight - valve with 1 solenoid	kg (lbs)	0.9 (1.98)
- valve with 2 solenoids		1.25 (2.76)
<b>Technical data of proportional solenoid</b>		
Nominal supply voltage	V DC	24
Limit current	A	0.8
Mean resistance value at 20 °C (68 °F)	$\Omega$	21
<b>Technical data of electronic control unit EL-7</b>		
Operating supply voltage $U_{cc}$	V DC	9 ... 32
Reference voltage $U_{ref}$	V DC	5
Max. current at $U_{ref}$	mA	20
Types of input command signal, when EL7 is used		see datasheet EL7*
Max. output current / 1 coil	A	3
PWM frequency	Hz	80 ... 1 000
Resolution of A/D converters	bit	12
Ramp function	s	0 ... 45
Dither – amplitude*	% from $I_{max}$	0 ... 30
Dither – frequency*	Hz	60 ... 300
* When the dither is activated, the PWM frequency is automatically set to 15 kHz		
	Datasheet	Type
General information	HA 0060	products and operating conditions
Coil types / Connectors	HA 8007 / HA 8008	C 19B* / K*
Mounting interface	HA 0019	Size 04
Spare parts	HA 8010	
Subplates	HA 0002	DP*-04

Ordering Code

PRMF2-04 / - - - - - - - - - -

Proportional directional control valve with position sensor

Valve size

Spool symbols see table „Spool Symbols“

Nominal flow rate at  $\Delta p=10$  bar (145 PSI)  
4 l/min (1.05 GPM) 04  
8 l/min (2.1 GPM) 08  
12 l/min (3.2 GPM) 12

Rated supply voltage of solenoid (at the coil terminal)  
24 V DC 24

Integrated electronic control unit (standardly on the solenoid „a“)  
Electronic control unit EL7-IA with an analogue input command signal EL7-A  
Electronic control unit EL7-IC for connection to the CAN bus EL7-C

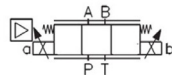

No designation B Surface treatment standard zinc-coated (ZnNi), ISO 9227 (520 h)

No designation V Seals NBR FPM (Viton)

No designation KM Connector plug of position sensor without connector plug connector plug M12x1 (4 pins)

S01 S02 S04 S06 Spool position sensor (always on the solenoid „a“) sensor with analogue output 0 - 5 V DC sensor with analogue output 4 - 20 mA sensor with analogue output 12 - 3 V DC sensor with analogue output 0 - 10 V DC

No designation N2 Manual override standard (operated by pin) rubber boot protected

No designation K1 Connector plug acc. to EN 175301-803-A valve with integrated electronic control unit connector plug EN 175301-803-A without rectifier for the valve without integrated ECU and with coils E1 or E2

E1 E2 E3 E4 E3A E4A E8 E9 E12A E13A Connector (only for valves without EL7-I) EN 175301-803-A E1 with quenching diode AMP Junior Timer - radial direction (2 pins; male) E3 with quenching diode AMP Junior Timer - axial direction (2 pins; male) E3A with quenching diode loose conductors (two insulated wires) E8 with quenching diode Deutsch DT04-2P - axial direction (2 pins; male) E12A with quenching diode

- For proportional valves with two solenoids, single solenoid must be de-energized before the other solenoid can be charged.
- Mounting bolts M5 x 35 DIN 912-10.9 or studs must be ordered separately. Tightening torque is 5+1 Nm (3.7+0.7 lbf.ft).
- Besides the shown, commonly used valve versions other special models are available.
- Contact our technical support for their identification, feasibility and operating limits.

Spool Symbols

Type	Symbol	Type	Symbol	Type	Symbol
2Z51		3Z11		3Z21	$\frac{Q_a}{Q_b} = \frac{2^*}{1}$
2Z11		3Z12	$\frac{Q_a}{Q_b} = \frac{1^*}{2}$	3Y21	$\frac{Q_a}{Q_b} = \frac{2^*}{1}$
2Y51		3Y11		*Model for cylinders with asymmetric piston area ratio	
2Y11		3Y12	$\frac{Q_a}{Q_b} = \frac{1^*}{2}$		

**Characteristics** measured at  $v = 32 \text{ mm}^2/\text{s}$  (156 SUS)

**Operating limits:** Flow direction  $P \rightarrow A / B \rightarrow T$  or  $P \rightarrow B / A \rightarrow T$

Nominal flow 4 l/min (1.1 GPM)

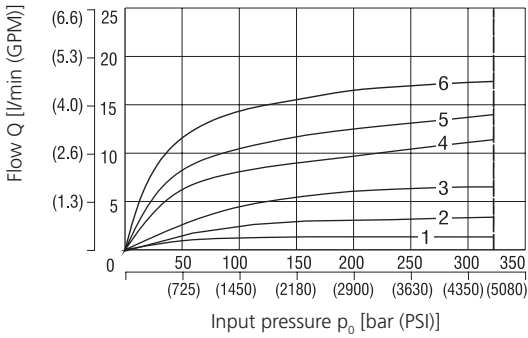

Nominal flow 8 l/min (2.1 GPM)

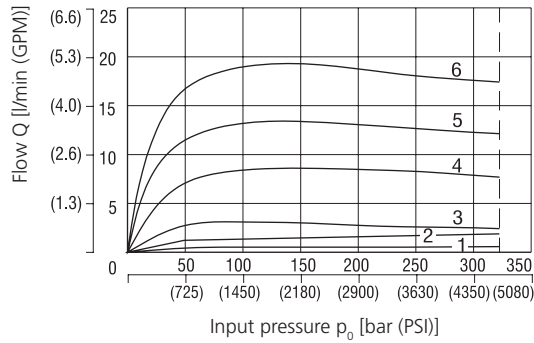

Nominal flow 12 l/min (3.2 GPM)

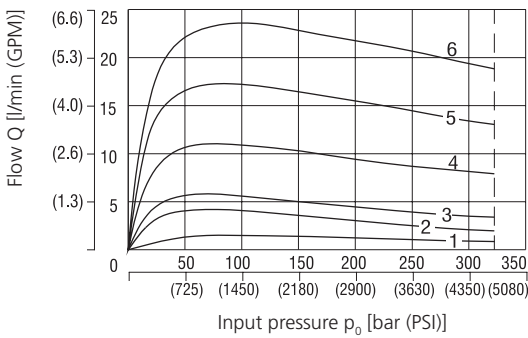

**Solenoid current:**

- 1 = 50 %
- 2 = 60 %
- 3 = 70 %
- 4 = 80 %
- 5 = 90 %
- 6 = 100 %

**Regulated flow related to control signal  $\Delta p = 10 \text{ bar}$  (145 PSI)**

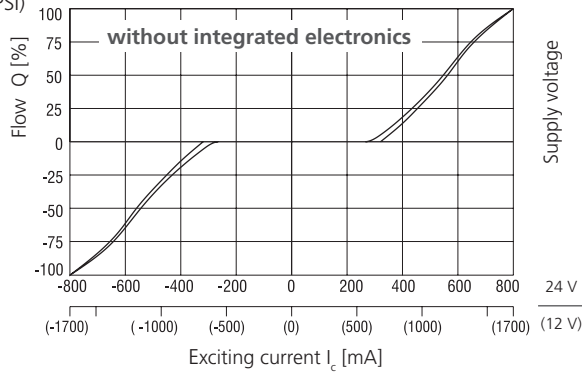
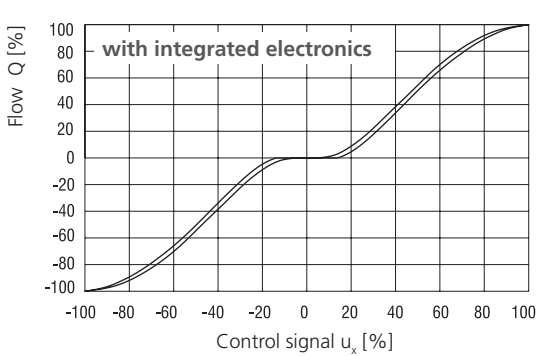

Supply voltage  
The coil current which initializes the flow through the proportional directional valve can differ due to the production tolerances about in a range of  $\pm 6\%$  of the limit current.

**Transient Characteristic** measured at  $v = 32 \text{ mm}^2/\text{s}$  (156 SUS),  $\Delta p = 10 \text{ bar}$  (145 PSI)

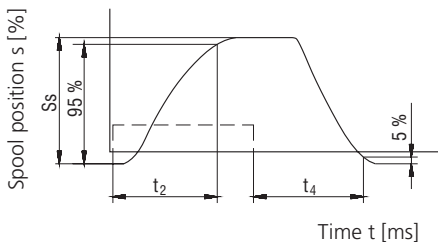

Steady Spool Position $S_s$ [%]	$t_2$ [ms]	$t_4$ [ms]
100	85	100
75	70	85
50	55	75
25	45	55

The values in table have only an informative character. The times of the transient characteristics at pressure or flow control will be in a particular hydraulic circuit always longer.

---- the control signal course of the integrated electronics

**Frequency Response**

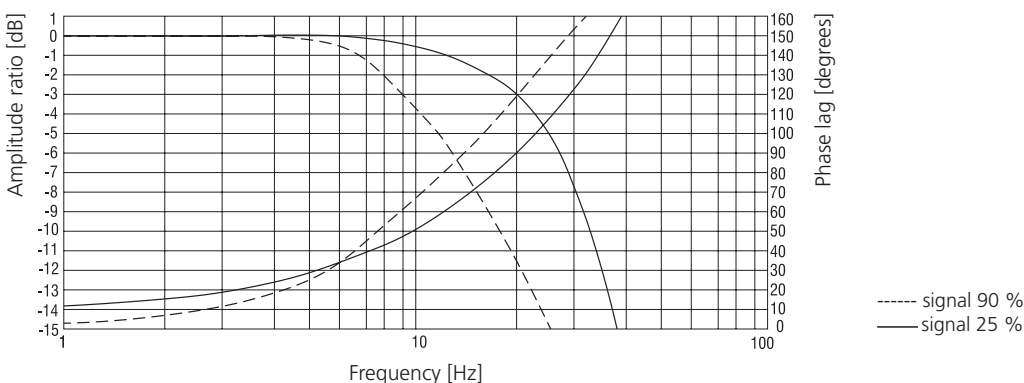

## Electronic control unit EL7

The ECU EL7 allows direct independent control of the valve with an analogue input command signal or connection of the valve to the CANBus control system of machine.

### Proportional valve with external electronic control unit EL7-E

The valve can be controlled by external ECU EL7-E designed for connection to a DIN rail. The user electrically connects the ECU to the valve with a cable. The ECU EL7-E can be used for control of single solenoid or two solenoid valves.

Selection and setting of ECU parameters is described in **datasheet HA 9152**

### Valve with single solenoid and integrated ECU EL7-I\*-1

The ECU in the form of connector plug is simply mounted on the socket of connector EN 175301-803-A of solenoid coil and fastened with a fixing screw.

### Valve with two solenoids and integrated ECU EL7-I\*-2-105

The ECU in the form of connector plug is simply mounted on the socket of connector EN 175301-803-A of solenoid coil and fastened with a fixing screw. The second solenoid is connected to the ECU with a cable. If the integrated ECU EL7-I is ordered separately, the length of cable must be specified. The length of cable is defined as a distance between fastening screws of ECU and connector plug.

Selection and setting of ECU parameters is described in **datasheet HA 9151**

## Spool position sensor

The spool position sensor is designed to monitoring of actual spool position by control system of machine. The proportional valve can thus operate in a closed control loop with feedback. The sensor works on the principle of differential transformer (LVDT). The sensor core is firmly mechanically connected with a rod to the solenoid armature, which is pressed by spring force to the face of spool inside the valve body. The ECU EL7 does not have any port for connection of sensor as a feedback and allows the valve control only in the open loop. A circular 4-pin M12x1 connector is used for an electrical connection. The surface of sensor is blue chromated.

## Technical Data

Max. fluid pressure	bar (PSI)	350 (5080)
Supply voltage	V DC	24 (±10 %)
Power current consumption	mA	> 20 (no load)
Linearity	% from the measuring range	< ±1
Repeatability	% from the measuring range	0.1
Temperature drift	% from the measuring range	< ±0.05
Current output signal	mA	4 ...20
Voltage output signal	V DC	0 ... 5 / 0 ... 10 / 12 ... 3
Load resistance – current output	Ω	< 500
Load resistance – voltage output	kΩ	> 10
Limit frequency	kHz	1
Stroke range of sensor core	mm (in)	±4 (0.158)
Weight with connector plug	kg (lbs)	0.240 (0.53)
Operating temperature range	°C (°F)	-40 ... +85 (-40 ... +185)
Storage temperature range	°C (°F)	-40 ... +85 (-40 ... +185)
Electrical enclosure protection		IP65*
Resistance to mechanical shocks		200 g, 2 ms
Resistance to vibrations		10 g / 2 Hz ... 2 kHz

\*under the condition of correctly mounted connector plug

**Electrical connection of sensor**

Pin 1	Supply voltage 24 ( $\pm 10\%$ ) V DC	
Pin 2	Output signal	
Pin 3	GND	
Pin 4	Unconnected	

**Dimensions of position sensor** in millimeters (inches)

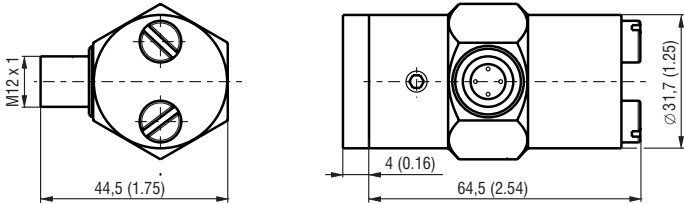

**Solenoid Coil** in millimeters (inches)

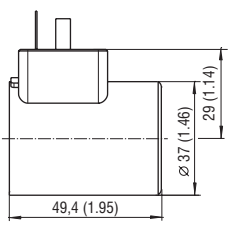
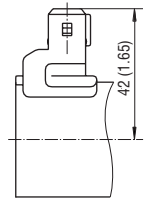
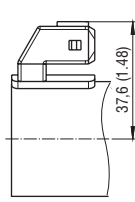
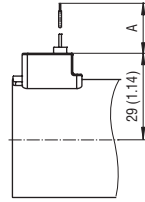
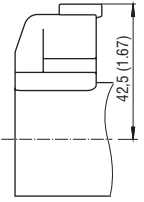
E1, E2 Protection Degree IP65	E3, E4 Protection Degree IP65 / IP67	E3A, E4A Protection Degree IP65 / IP67	E8, E9	E12A, E13A Protection Degree IP67 / 69K
			 <p>Note: A = Standard 300 mm (11.8 in), other lengths on demand</p>	

The specified IP rating applies only in the case of correctly connected connectors (male + female) with the corresponding IP rating.

**Manual Override** in millimeters (inches)

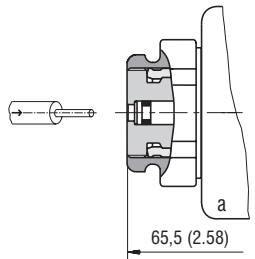
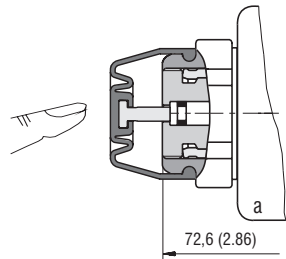
No Designation - Standard (operated by pin)	Designation N2 - Rubber Boot Protected
	

In case of solenoid malfunction or power failure, the spool of the valve can be shifted by manual override as long as the pressure in port T does not exceed 25 bar (363 PSI). For alternative manual overrides contact our technical support.

**Dimensions** in millimeters (inches)

**PRMF2-043..../....E1K1..S...KM...**

Valve with two solenoids and position sensor  
Example with electrical terminal  
EN 175301-803-A (E1, E2)

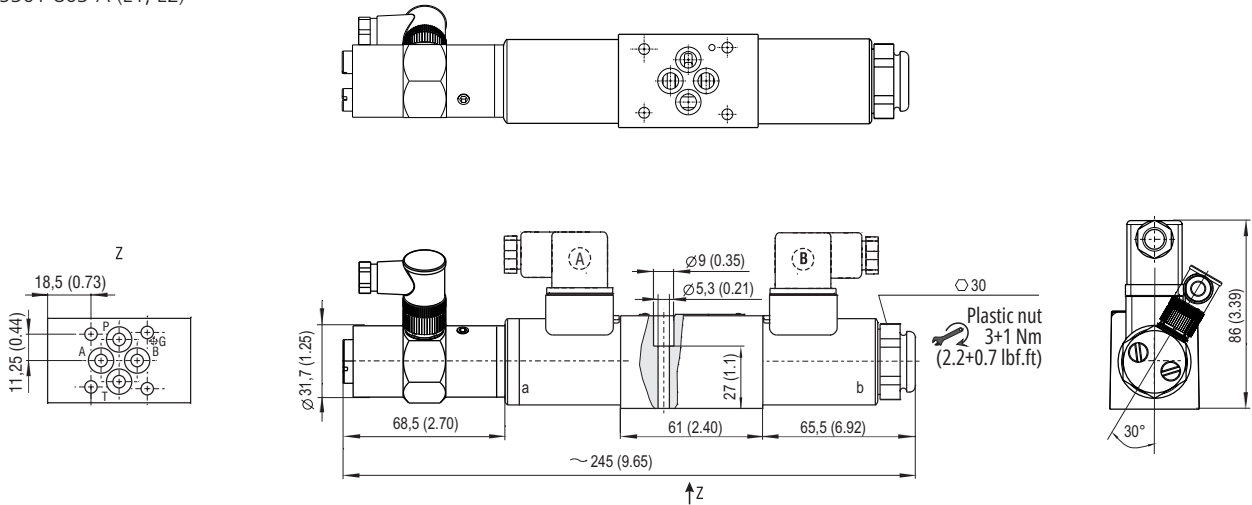

**PRMF2-042..../....E1K1...S...KM...**

Valve with single solenoid „a” and position sensor  
Spool type 2Z51, 2Y51

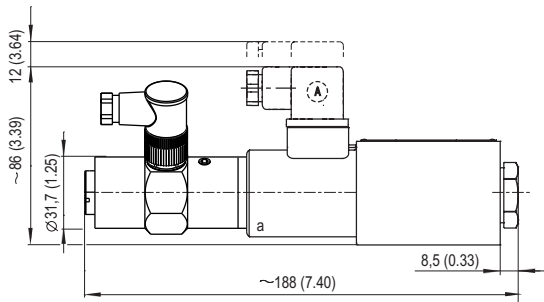

**PRMF2-042..../....E1K1...S...KM...**

Valve with single solenoid „b” and position sensor  
Spool type 2Z11, 2Y11



**PRMF2-042..../....EL7...S0...**

Valve with single solenoid „a”, integrated electronic control unit EL-I\*-1 and position sensor

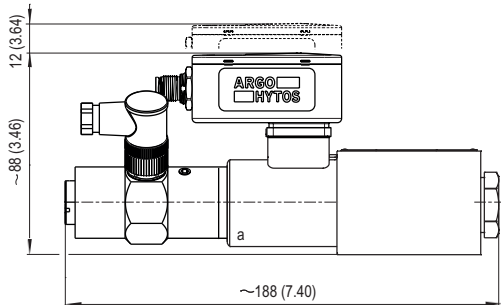

**PRMF2-043..../....EL7...S0...**

Valve with two solenoids, integrated electronic control unit EL-I\*-2-105 and position sensor

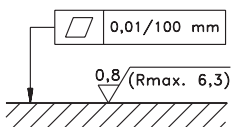
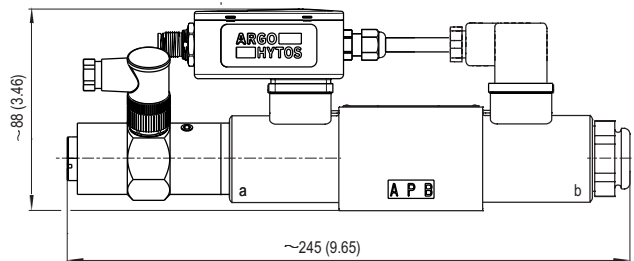

Required surface quality of the counterpart

Mounting screws 5+1 Nm (3.7+0.7 lbf.ft)  
M5 x 35 DIN 912-10.9